

LDA-906V Lab Brick® High Resolution Digital Attenuator

200 – 6000 MHz Frequency | 90 dB Attenuation Range | 0.1 Step Size

Features/Benefits

- Reliable and Repeatable solid state digital attenuation
- Includes GUI, Windows and Linux SDK, LabVIEW driver
- Programmable attenuation ramp and fading profiles
- Operate multiple devices directly from a PC or self powered hub
- Easily portable USB powered device
- Sized to fit into a single rack unit for ATE applications



Applications

- WiMAX, 3G, 4G, 5G, LTE, DVB, Microwave Radio Fading Simulators
- Engineering/Production Test Labs
- Automated Test Equipment (ATE)

The Lab Brick LDA series of Digital Attenuators bring affordability, functionality, reliability and simplicity to the microwave test bench. The LDA products range from 6 MHz to 20 GHz with input level tolerance to 2 Watts and step size as small as 0.1 dB.

Lab Bricks use a native USB HID interface to avoid the difficulties inherent in using older serial or IEEE-488 interfaces implemented over USB. As a result, Lab Brick users can get to work faster without having to install kernel level drivers, and Lab Brick devices can be easily used on any system that supports USB HID devices, including low cost embedded computers using Linux or similar operating systems.

The LDA-906V Digital Attenuator is a highly accurate, bidirectional, 50 Ohm step attenuator. The LDA-906V provides calibrated attenuation from 200 to 6000 MHz with an amazing step size of 0.1 dB and typical accuracy <0.25 dB over 90 dB of control range. The attenuators are easily programmable for fixed attenuation, swept attenuation ramps and fading profiles directly from the included Graphical User Interface (GUI). Alternatively, for users wishing to develop their own interface, Vaunix supplies LabVIEW drivers, Windows API DLL files, Linux drivers, Python examples and much more.

LDA-906V Specifications

Parameter	Test Conditions	Min	Typ	Max
Frequency Range (MHz)		200		6000
Impedance (Ω)			50	
Attenuation Range (dB)		90		
Step Size (dB)		0.1		
Insertion Loss (dB)	< 2 GHz		5	6
	< 4 GHz		6.5	7.5
	< 6 GHz		8.5	10.5
Attenuation Accuracy (dB)	+25 °C		0.25	1
	-30 °C to +70 °C		1	2.5
Switching Speed (μ s)			15	
Maximum Input Level (dBm)	<1 GHz		26	
	1 – 6 GHz		28	
Input IP3 (dBm)		44	47	
VSWR			1.5:1	

Parameter	Test Conditions/Notes	
Power Requirements	From the USB connection	+5 VDC 75 mA
Environmental	Operating Temperature	-30 °C to +70 °C
	Relative Humidity (non-condensing)	<95%
Physical Connections	Power and Control	USB Type B – female
	RF Connectors	SMA – female
Operating Modes	Manual Attenuation Control Swept Attenuation – uni/bi directional – one time/repeat Profile	
Mechanical	Size	4.27 x 1.97 x 0.86 inches 108.5 x 50 x 21.8 millimeters
	Weight	0.4 pounds 0.182 kilograms

LDA-906V Performance Plots

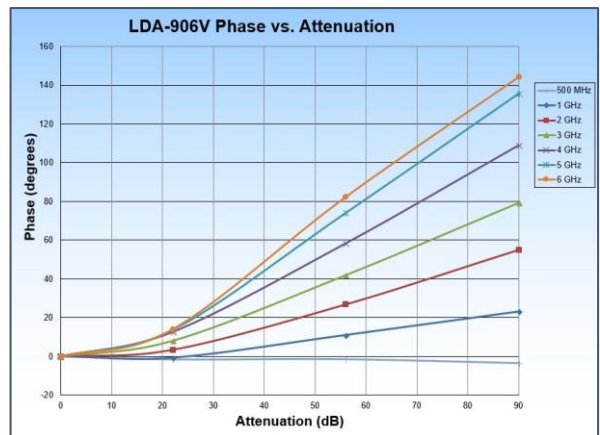
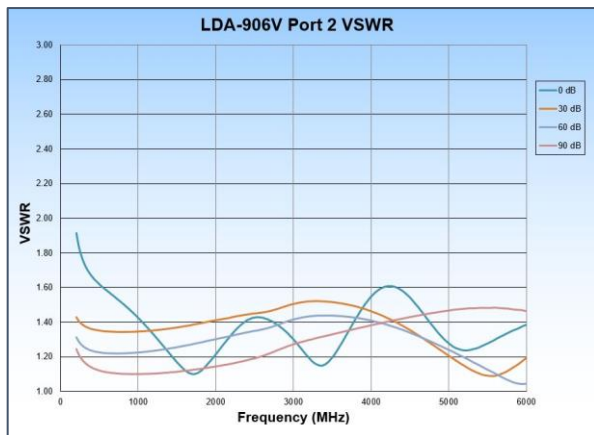
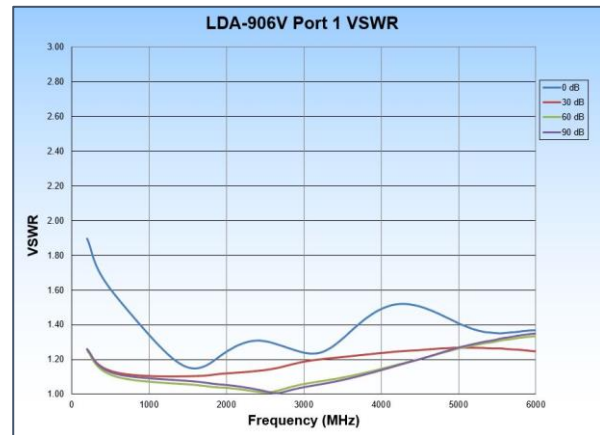
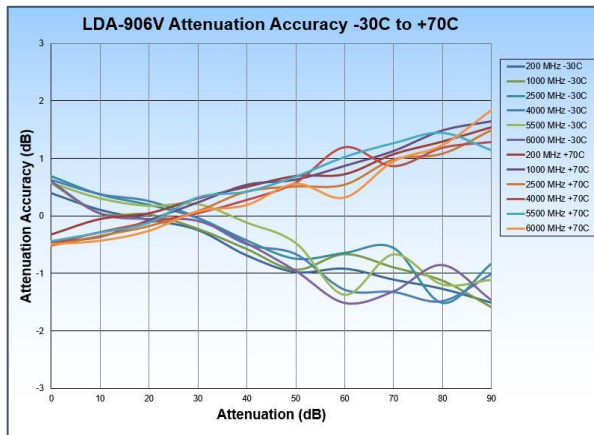
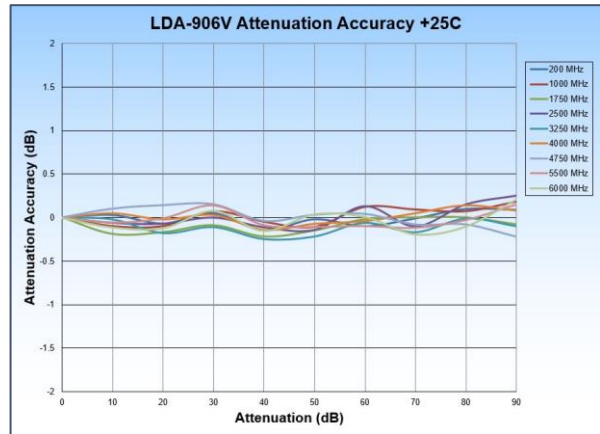
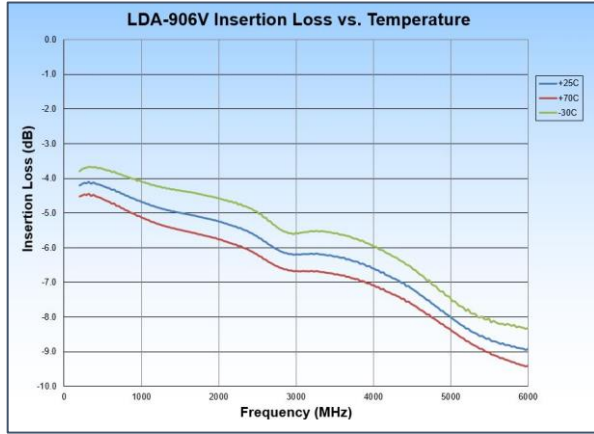

LDA-906V Mechanical Outline

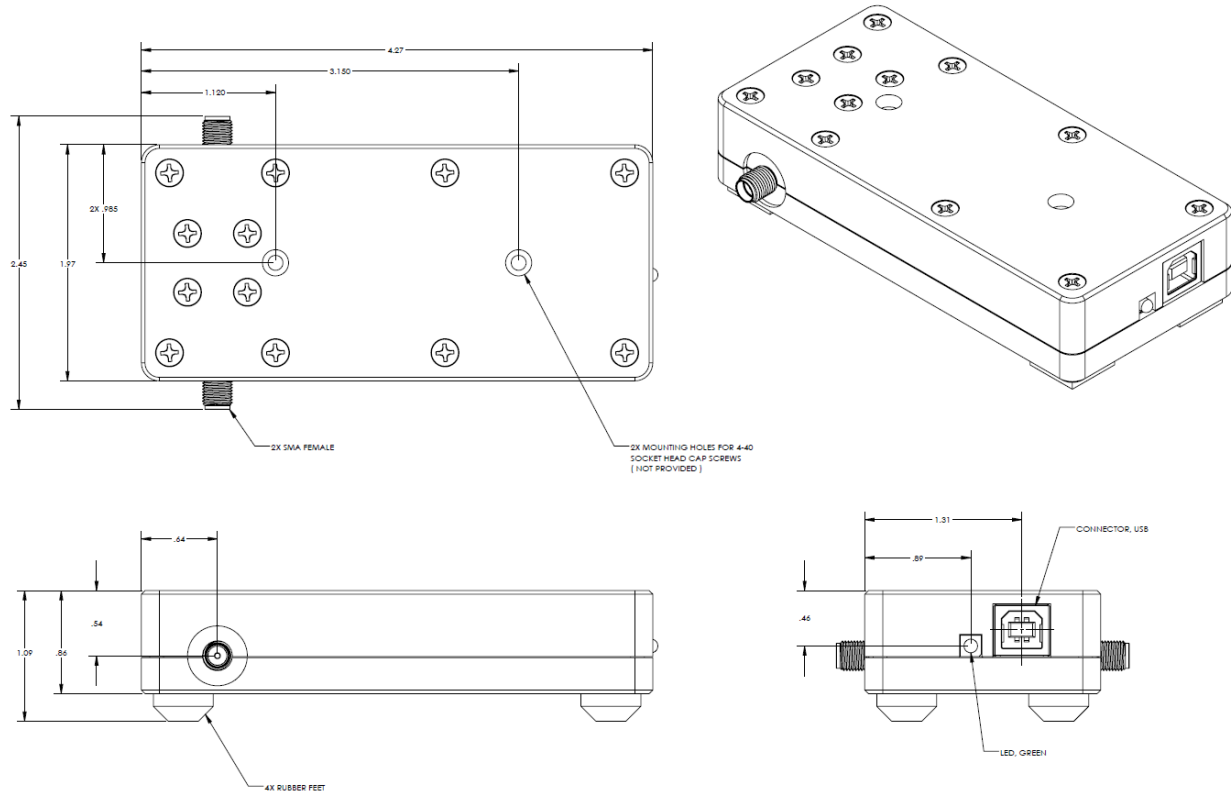

LDA-906V Software Interface

